

45 G-72 1F

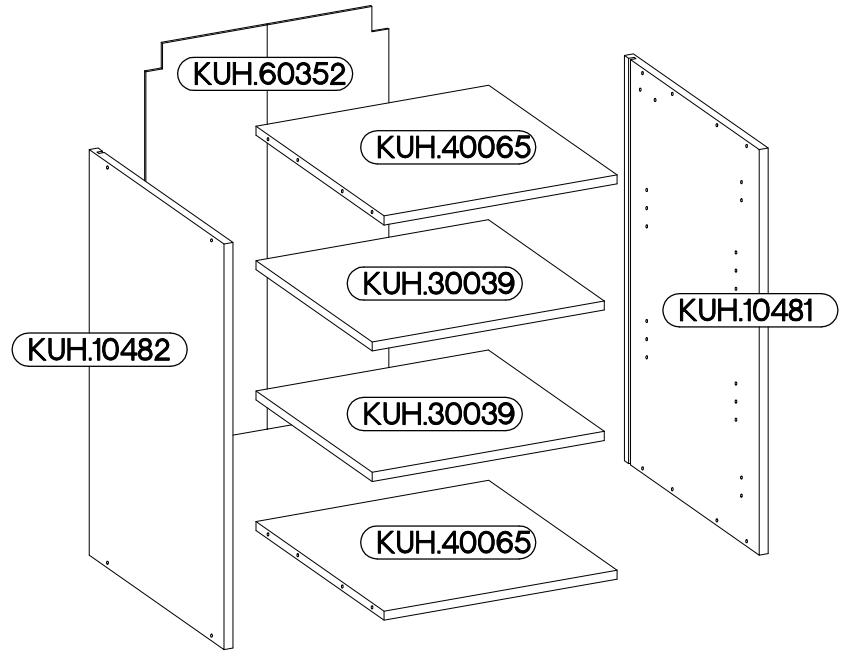

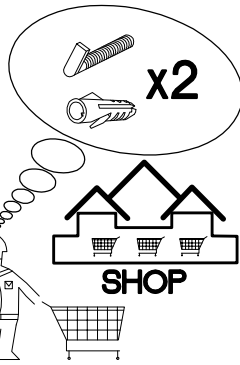
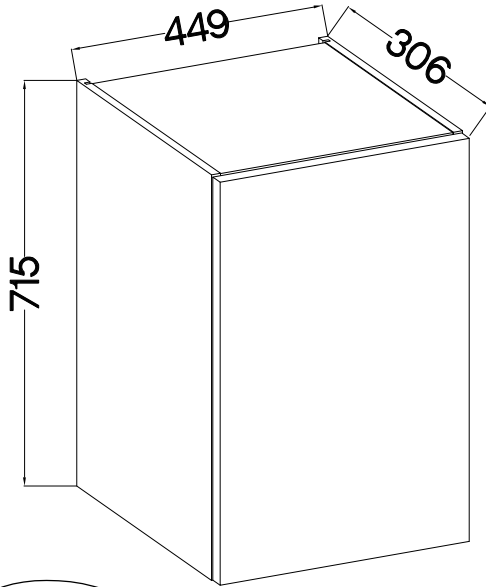
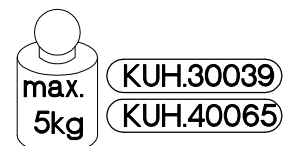

Ersatzteil Nummer	Dimension
KUH.10481	715x290x16
KUH.10482	715x290x16
KUH.30039 x2	416x250x16
KUH.40065 x2	417x276x16
KUH.60352	713x435x2,5

$\pm 8 \times 30 \text{mm}$ A	$6,4 \times 50 \text{mm}$ B	E1	$\pm 35 / 0 \text{mm}$ HG	$\pm 5 / 19 \text{mm}$ J	
8	8	8	2	8	
L K25	R K26	O	$\pm 3,5 \times 13 \text{mm}$ P5	$\pm 3,0 \times 20 \text{mm}$ P7	$\pm 4,0 \times 30 \text{mm}$ P8
1	1	1	4	8-10	4



ISM-KUH-01787

1

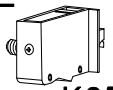
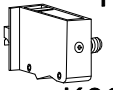
$\pm 8 \times 30 \text{mm}$  A 8	$\pm 4.0 \times 30 \text{mm}$  P8 4	L  K25 1	R  K26 1
---	--	---	---

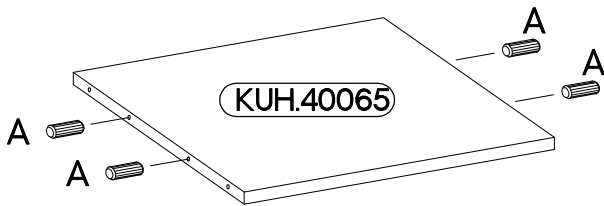
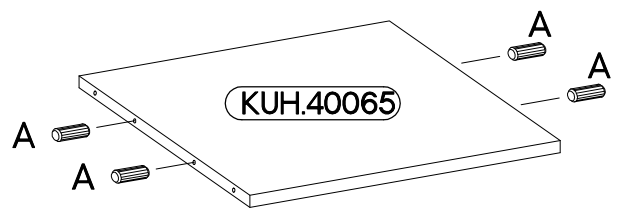
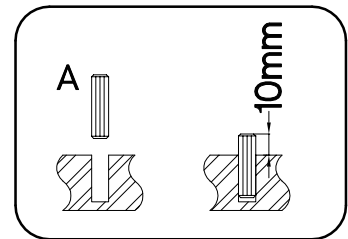
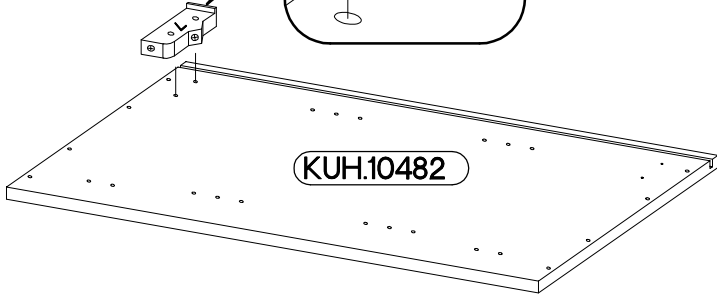
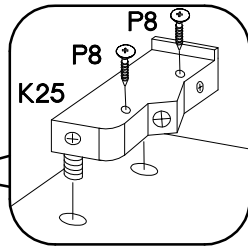
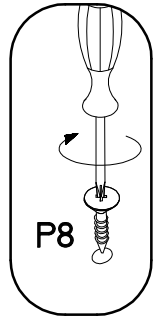
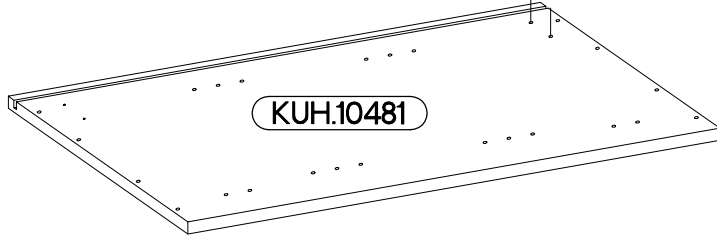
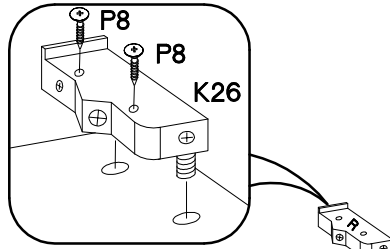
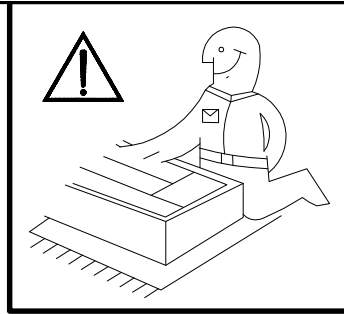

2

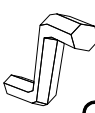
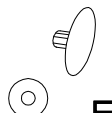
6,4 x 50mm		
		
B	O	E1
4	1	4

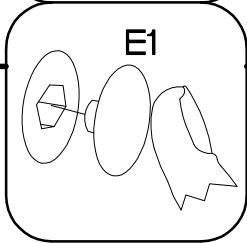
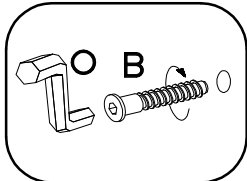
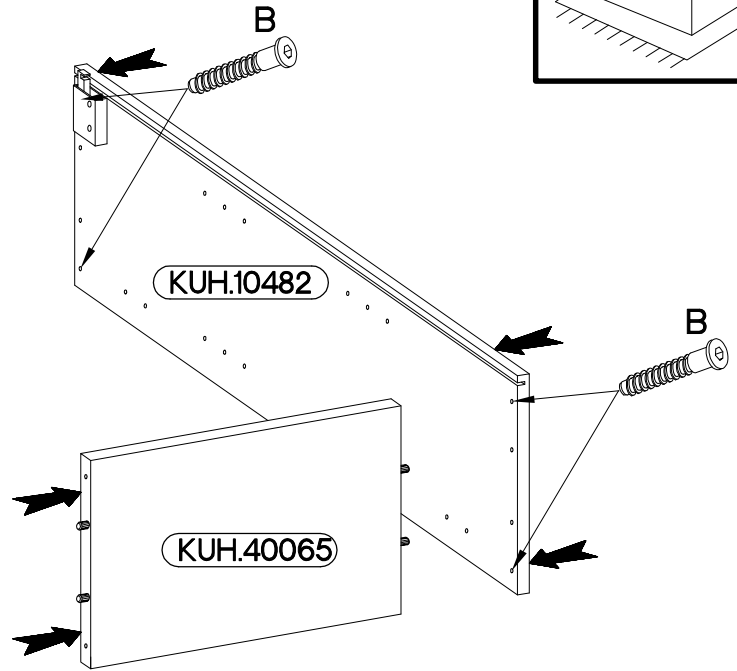
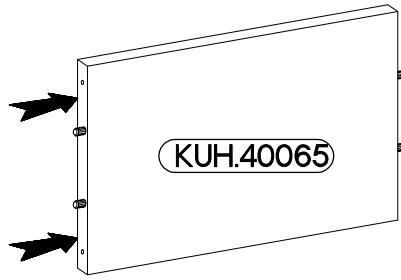
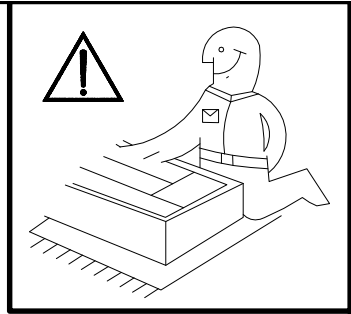

3

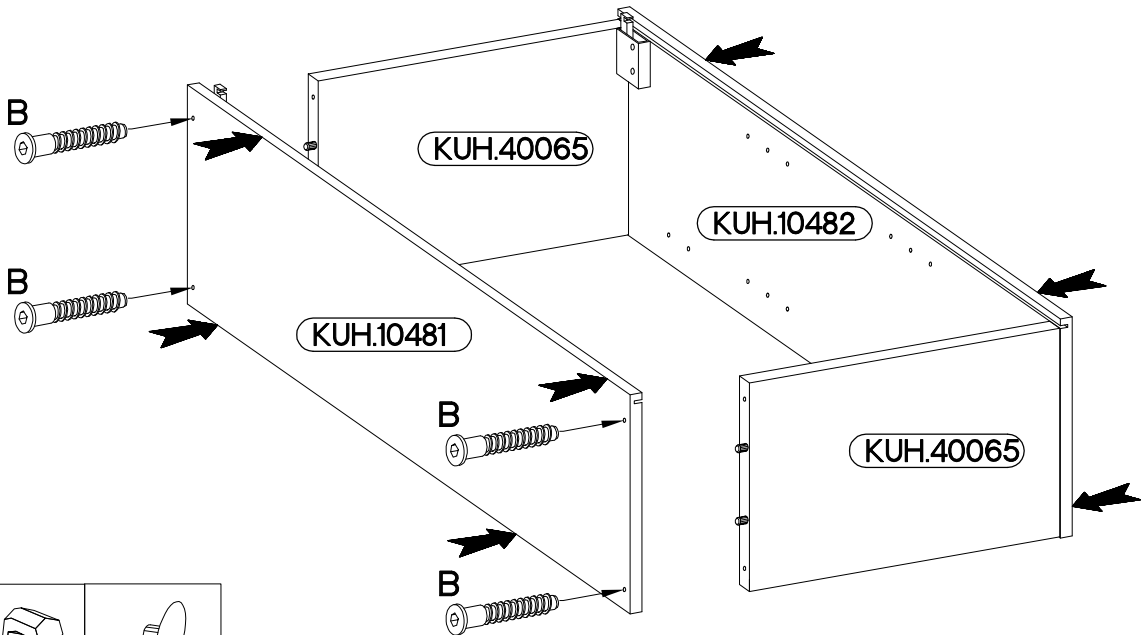

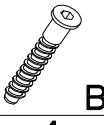
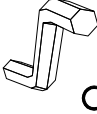
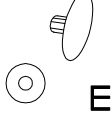
6,4 x 50mm		
		
B	O	E1
4	1	4

4

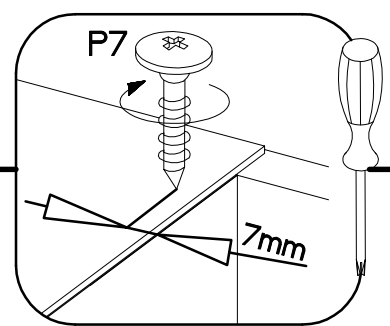
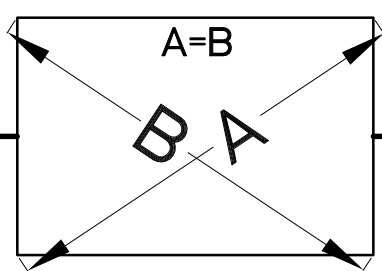
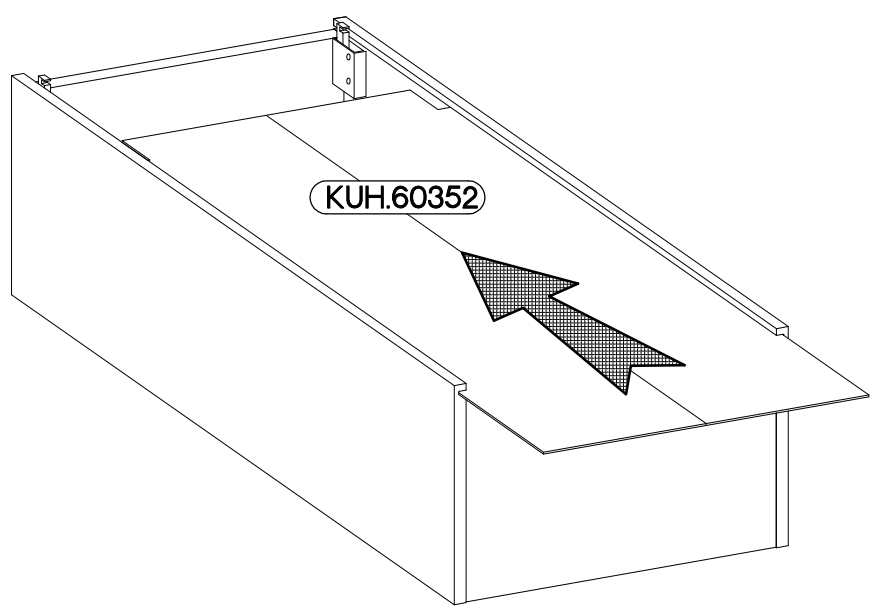
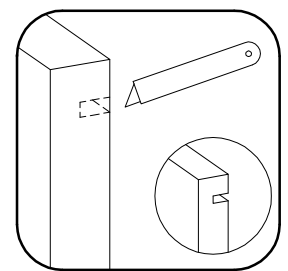
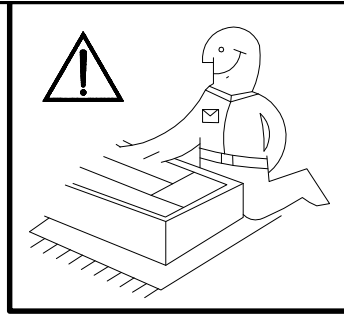

5

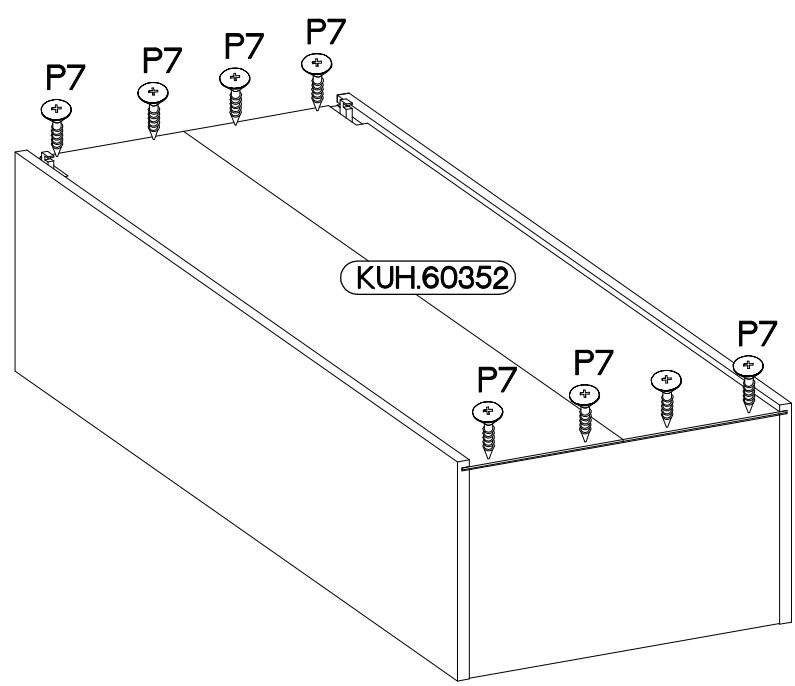
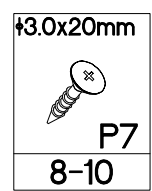

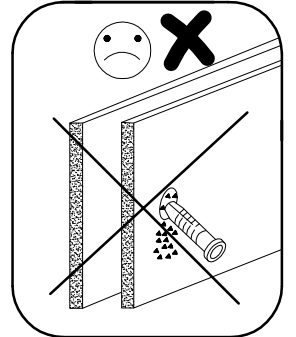
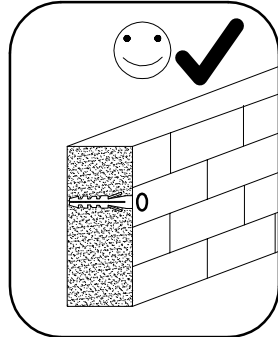
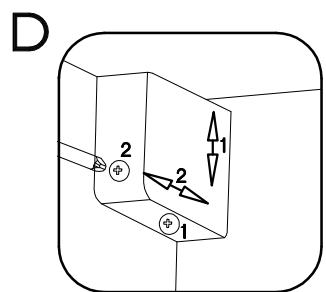
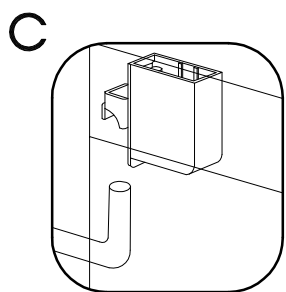
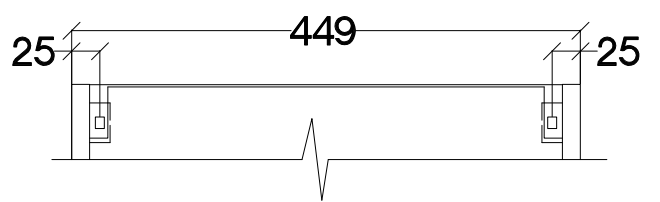
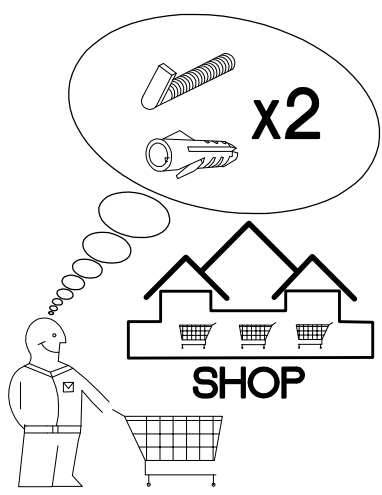
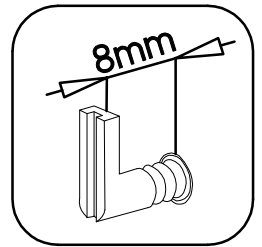
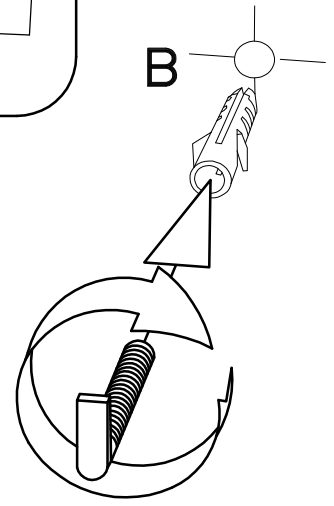
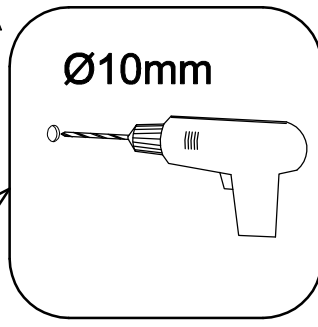
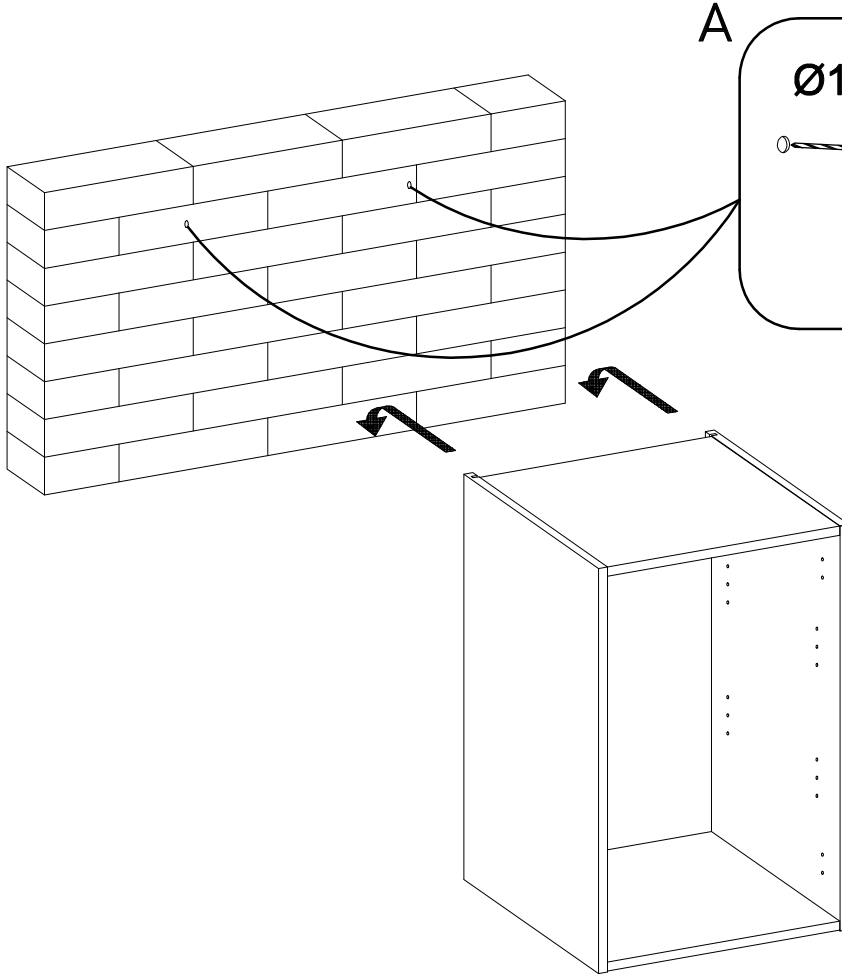
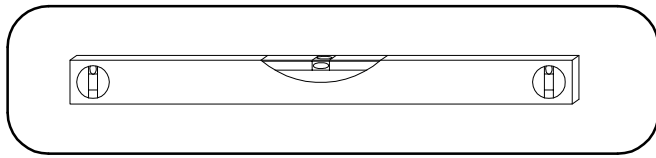

7

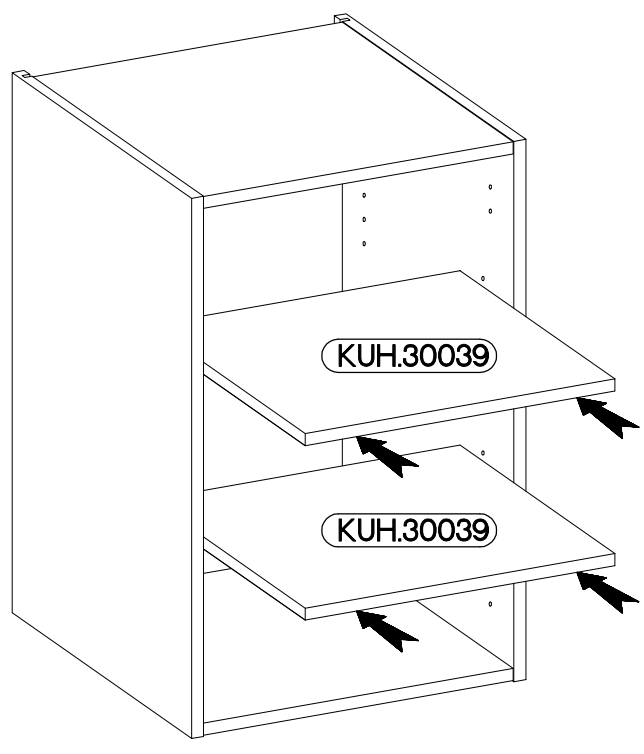
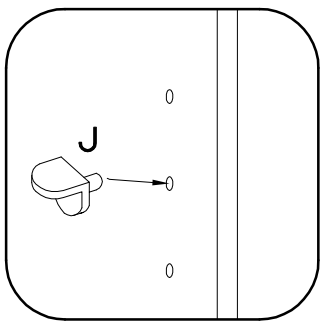
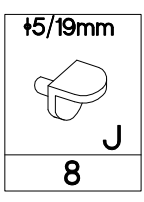

8

FRONT

